

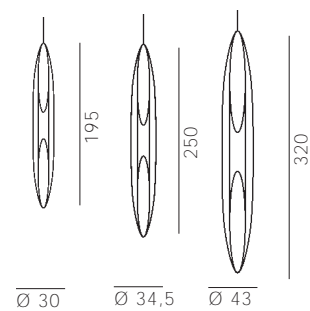





SHAKTI AIR

MARZIO RUSCONI CLERICI / 2002



- 200 | 6 x 75W E27 
Clear
- OR 6 x 21W E27 Fluo 
- 250 | 6 x 75W E27 
Clear
- OR 6 x 25W E27 Fluo 
- 320 | 6 x 75W E27 
Clear
- OR 6 x 25W E27 Fluo 



canopy / *rosone*
white <

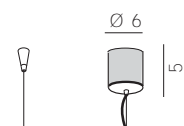

Suspension lamp, made of three plexiglas laser cut diffusers, electrified with cable dimmer and plug or with ceiling fixture.

Lampada a sospensione dimmerabile composta da tre diffusori in plexiglas tagliati a laser, elettrificati con cavo e spina a terra o con rosone a soffitto.

Dimmbare Hängeleuchte mit Kabel und Stecker, die aus drei lasergeschnittene Plexiglasdiffuser besteht. Deckenleuchteversion erhältlich.

Lampe à suspension dimmerable composée de trois diffuseurs en plexiglas coupés laser, électrifiés par un câble et une prise de terre ou à plafond.

Lámpara colgante con dimmer, compuesta por tres difusores de plexiglás cortados con láser, electrificados con cable y enchufe o con florón a techo.

